

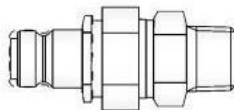

超高壓快速接頭

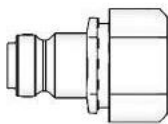

C Series High Pressure Quick Connect Couplings

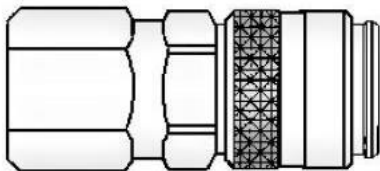

- Working pressures to 29,000 psi.
- Non-drip valving for clean, safe trouble-free performance and minimal air inclusion.
- Built-in safety locking device to prevent accidental disconnect.
- Wide range of threaded styles NPT, BSP and "High Pressure."
- Adapters for ease of connection to high pressure hoses and fixed ports.
- Thread sizes from 1/8" to 3/8".
- Protective dust caps are included to prevent damage and fluid contamination in disconnected position.
- Rugged design and construction for long life in demanding applications.

Model Code Breakdown

C10-XXX

Working Pressure

115 = 14,500

116 = 21,800



125 = 29,000

NOTE: The choice of the threaded end form may limit the working pressure and the size of the thru hole in the coupling.

Coupling

C10 - 115 - XXX

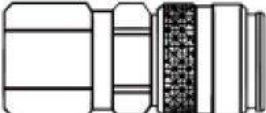
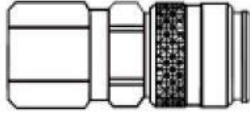
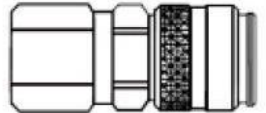
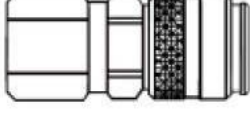
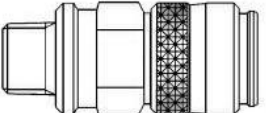

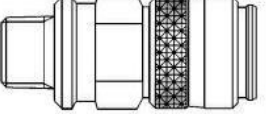
	-1202 1/4" Female BSP		-1404 3/8" Female National Pipe Tapered (NPT)
	-1222 1/4" Female BSP (with built-in locking device)		-1422 1/4" Female National Pipe Tapered (NPT) (with built-in locking device)
	-1401 1/8" NPT Female National Pipe Tapered (NPT)		-1452 1/4" Male National Pipe Tapered (NPT)
	-1402 1/4" Female National Pipe Tapered (NPT)		-1454 3/8" Male National Pipe Tapered (NPT)

C10-115

Nipple

C10 - 115 - XXX

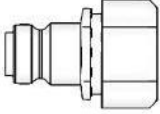
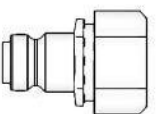
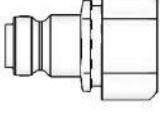
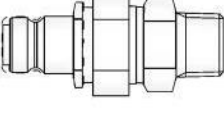
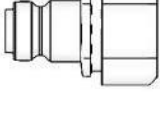
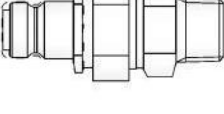
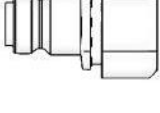
	-6202 1/4" Female BSP		-6404 3/8" Female National Pipe Tapered (NPT)
	-6204 3/8" Female BSP		-6452 1/4" Male National Pipe Tapered (NPT)
	-6401 1/8" Female National Pipe Tapered (NPT)		-6454 3/8" Male National Pipe Tapered (NPT)
	-6402 1/4" Female National Pipe Tapered (NPT)		

C10-116

Coupling

C10 - 116 - XXX

--	--	--	--

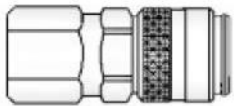
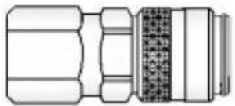
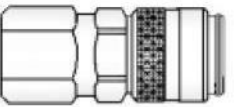
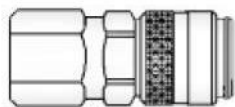
	-1202 1/4" Female BSP		-1402 1/4" Female National Pipe Tapered (NPT)
	-1222 1/4" Female BSP (with built-in locking device)		-1422 1/4" Female National Pipe Tapered (NPT) (with built-in locking device)

C10-116

Nipple

C10 - 116 - XXX

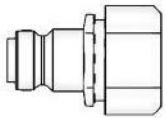
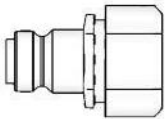
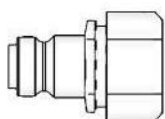
			-5202 1/4" Female BSP (Thru type, 15,000 psi)
	-6202 1/4" Female BSP		-6402 1/4" Female National Pipe Tapered (NPT)